

# KIT ANTICICLISTAS CYCLIST KNOCK DOWN PREVENTION KIT



## KIT ANTICICLISTAS CYCLIST KNOCK DOWN PREVENTION KIT

### KIT CON SOPORTES ABATIBLES KIT WITH RETRACTABLE BRACKETS



Material	Peso	Acabado	Largo (L)	Soportes	Ref.
Varios	8.28kg		1000	2	NAC10
Varios	9.68kg		1500	2	NAC15
Varios	11.08kg		2000	2	NAC20
Varios	12.48kg		2500	2	NAC25
Varios	13.88kg		3000	2	NAC30
Varios	15.28kg		3500	2	NAC35
Varios	16.68kg		4000	2	NAC40
Varios	18.08kg		4500	2	NAC45
Varios	19.48kg		5000	2	NAC50

Nota

### KIT CON SOPORTES FIJOS KIT WITH FIXED BRACKETS



Material	Peso	Acabado	Largo (L)	Soportes	Ref.
Varios	11.56kg		1000	2	NACF10
Varios	12.96kg		1500	2	NACF15
Varios	14.36kg		2000	2	NACF20
Varios	15.76kg		2500	2	NACF25
Varios	17.16kg		3000	2	NACF30
Varios	18.56kg		3500	2	NACF35
Varios	19.96kg		4000	2	NACF40
Varios	21.36kg		4500	2	NACF45
Varios	22.76kg		5000	2	NACF50

Nota

## ACCESORIOS KIT ANTICICLISTAS ACCESSORIES FOR CYCLIST KNOCK DOWN PREVENTION KIT

### PERFIL RECTO STRAIGHT PROFILE

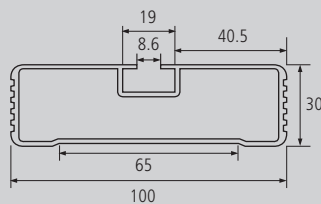

Material	Peso (p/m)	Acabado	Extra	Ref.
Aluminio	1.40kg			NPA

### PERFIL CANTONERA "D" "D" EDGE PROFILE

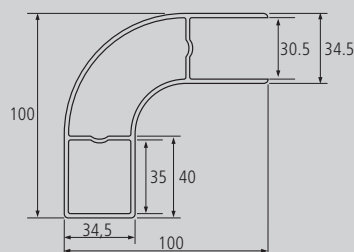

Material	Peso (p/m)	Acabado	Extra	Ref.
Aluminio	1.96kg			NACA



**CANTONERA DELANTERA  
FRONT EDGE**

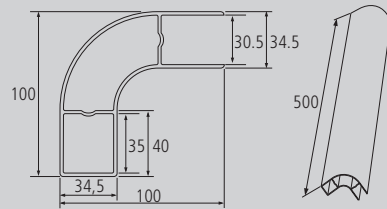

Material	Peso	Acabado	Longitud	Ref.
Aluminio	0.98kg		500	NCDAS

**TERMINAL PLÁSTICO "D" PARA CANTONERA  
"D" PLASTIC END FOR EDGE**

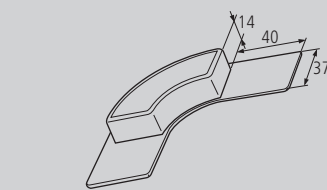

Material	Peso	Acabado	Extra	Ref.
Plástico	0.026kg	Negro		NTDA

**TERMINAL PLÁSTICO PARA PERFIL RECTO  
PLASTIC END FOR STRAIGHT PROFILE**

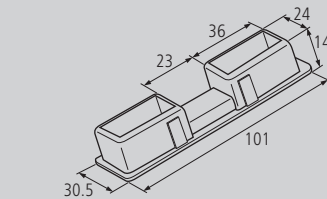

Material	Peso	Acabado	Extra	Ref.
Plástico	0.020kg	Negro		NTTA

**SOPORTE ARTICULADO PARA KIT ANTICICLISTA  
JOINTED BRACKET FOR CYCLIST KNOCK DOWN PREVENTION KIT**



\* Ref. NSAA

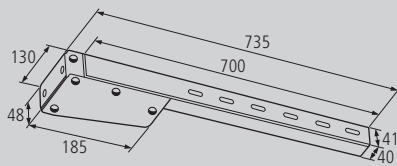

Material	Peso	Acabado	Extra	Ref.
Acero	2.16kg	Cincado		NSAA *
Acero INOX	2.56kg			NSAI

**SOPORTE FIJO PARA KIT ANTICICLISTAS  
FIXED BRACKET FOR CYCLIST KNOCK DOWN PREVENTION KIT**

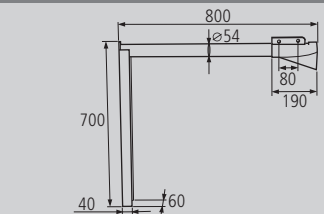

Material	Peso	Acabado	Extra	Ref.
Acero	3.80kg	Cincado		NSFA

**PLETINA ACERO (1 TALADRO) PARA KIT ANTICICLISTAS  
STEEL SHEET (1 DRILL HOLE) FOR CYCLIST K. D. P. KIT**

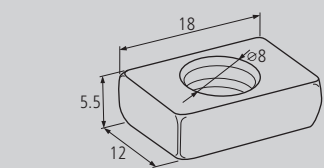

Material	Peso	Acabado	Extra	Ref.
Acero	0.008kg	Cincado		NPKA

**KIT ANTICICLISTAS  
CYCLIST K. D. P. KIT**



KIT ANTICICLISTAS  
CYCLIST K. D. P. KIT

**TORNILLO ALLEN (M-8x10)  
ALLEN BOLT (M-8x10)**

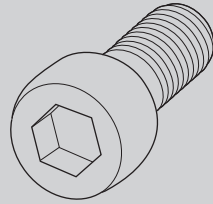

Material	Peso	Acabado	Métrica	Longitud	Ref.
Acero		Cincado	M-8	10	BT810
Nota					

**HOMOLOGACIÓN KIT KIT HOMOLOGATION**



**VEHICULOS MOTORIZADOS CLASE N2 y N3 MOTORIZED VEHICLES N2 AND N3 TYPES**

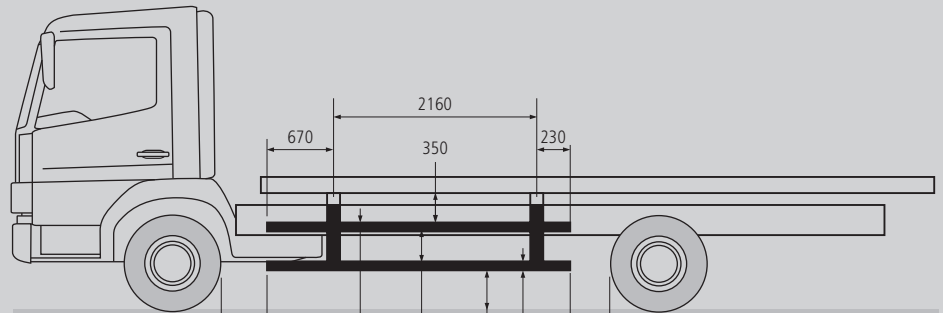

Elemento móvil — 100 \*  
 \* Elemento fijo — 25

950 mínimo (sólo cuando no se cumplen los 350mm. a la carrocería porque la altura de la carrocería sea mayor de 1.300mm.)

**REMOLQUES CLASES 03 Y 04 TRAILERS 03 AND 04 TYPES**

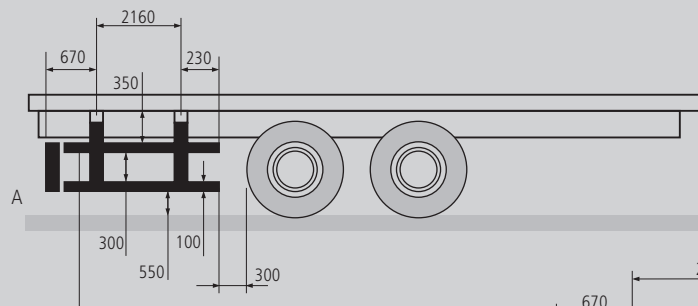

950 mínimo (sólo cuando no se cumplen los 350mm. a la carrocería porque la altura de la carrocería sea mayor de 1.300mm.)

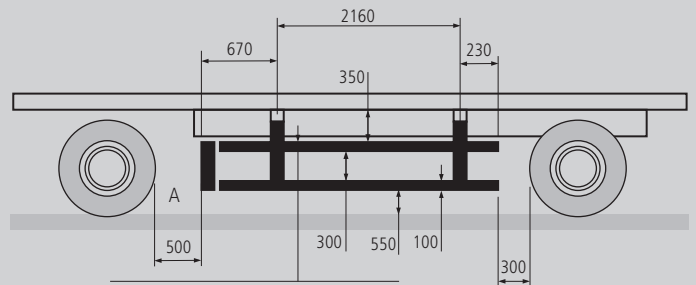

950 mínimo (sólo cuando no se cumplen los 350mm. a la carrocería porque la altura de la carrocería sea mayor de 1.300mm.)



**SEMIRREMOLQUE CLASES 03 Y 04 SEMI-TRAILER 03 AND 04 TYPES**

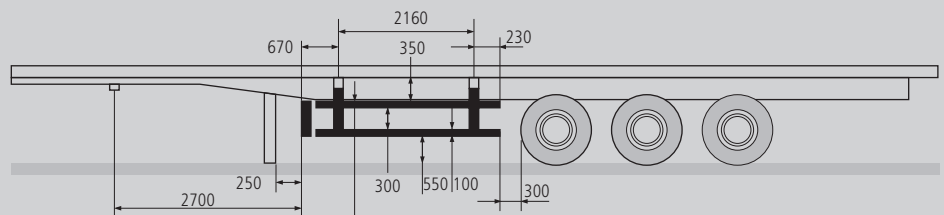

950 mínimo (sólo cuando no se cumplen los 350mm. a la carrocería porque la altura de la carrocería sea mayor de 1.300mm.)

**CASOS GENERICOS GENERIC CASES**

Los elementos fijados de forma permanente al vehículo, por ejemplo, cajones, depósitos, porta-palets, etc., cumpliendo las medidas del protector, podrán estar incorporados al protector lateral, siempre que el hueco máximo sea inferior a 25 mm., y no tener aristas inferiores a 2,5 mm., cumpliendo así el punto 2.2 de la Directiva.

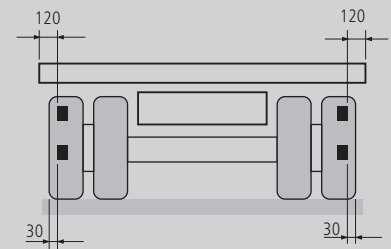
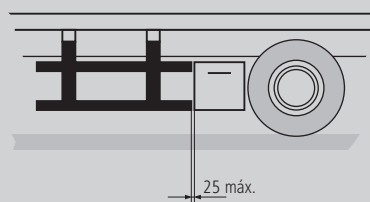

**SOPORTES ARTICULADOS, MONTAJE Y MEDIDAS MÁXIMAS JOINTED BRACKETS, ASSEMBLY AND MAX. MEASUREMENTS**



**MEDIDAS MÁXIMAS PERMITIDAS EN NUESTRO PRODUCTO  
PERMITTED MAXIMUM MEASUREMENTS FOR OUR PRODUCT**

Cotas	Denominación	Máximo
A	Voladizo Delantero	900
B	Distancia entre Apoyos	3080
C	Voladizo Trasero	190
D	Longitud Total	4170
E	Amarre a Chasis-Barra abajo	690
F	Distancia entre Barras	300

