

CIERRES PARA CARTOLA DROPSIDE CATCH

CIERRES PARA CARTOLA DE ALUMINIO Y DE ACERO ALUMINIUM AND STEEL DROPSIDE CATCHES

CIERRES PARA CARTOLA MODELO "AC" DROPSIDE CATCHES MODEL "AC"

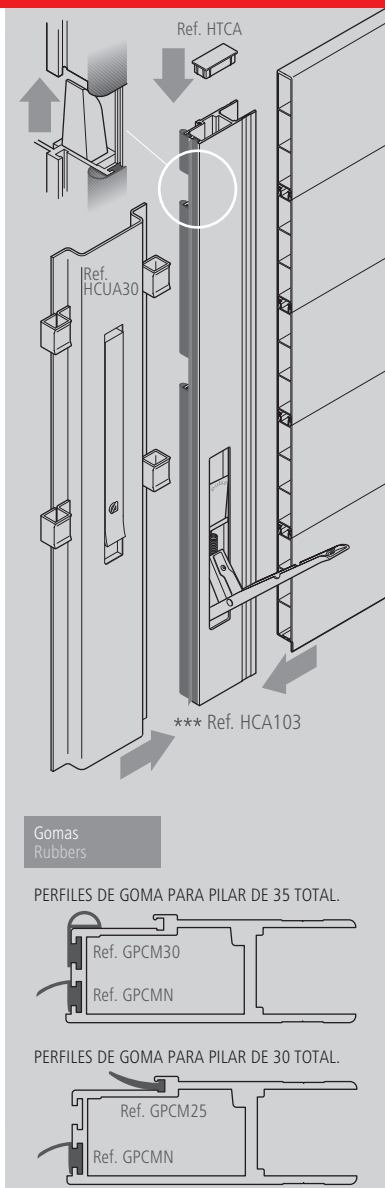

Material	Peso	Acabado	Nº de enganches	Alto(A)	Grosor(B)	Ref.
Acero	1.39kg		1	400	25	HCH425
Acero	1.54kg		1	500	25	HCH525 *
Acero	1.74kg		1	600	25	HCH625
Acero	2.10kg		1	700	25	HCH725
Acero	2.25kg		1	800	25	HCH825
Acero	2.75kg		2	900	25	HCH925
Acero	2.90kg		2	1000	25	HCH102
Acero	3.45kg		2	1100	25	HCH112
Acero	3.61kg		2	1200	25	HCH122
Acero	3.76kg		2	1300	25	HCH132
Acero	1.45kg		1	400	30	HCH430
Acero	1.62kg		1	500	30	HCH530
Acero	1.84kg		1	600	30	HCH630
Acero	2.21kg		1	700	30	HCH730
Acero	2.38kg		1	800	30	HCH830
Acero	2.89kg		2	900	30	HCH930
Acero	3.06kg		2	1000	30	HCH103
Acero	3.63kg		2	1100	30	HCH113
Acero	3.80kg		2	1200	30	HCH123
Acero	3.97kg		2	1300	30	HCH133
Aluminio	1.26kg		1	400	25	HCA425
Aluminio	1.30kg		1	500	25	HCA525
Aluminio	1.50kg		1	600	25	HCA625
Aluminio	1.76kg		1	700	25	HCA725
Aluminio	1.90kg		1	800	25	HCA825
Aluminio	2.30kg		2	900	25	HCA925
Aluminio	2.48kg		2	1000	25	HCA102
Aluminio	2.56kg		2	1100	25	HCA112
Aluminio	2.74kg		2	1200	25	HCA122
Aluminio	2.92kg		2	1300	25	HCA132
Aluminio	1.26kg		1	400	30	HCA430 **
Aluminio	1.30kg		1	500	30	HCA530
Aluminio	1.50kg		1	600	30	HCA630
Aluminio	1.76kg		1	700	30	HCA730
Aluminio	1.90kg		1	800	30	HCA830
Aluminio	2.30kg		2	900	30	HCA930
Aluminio	2.48kg		2	1000	30	HCA103 ***
Aluminio	2.56kg		2	1100	30	HCA113
Aluminio	2.74kg		2	1200	30	HCA123
Aluminio	2.92kg		2	1300	30	HCA133

Nota
Se pueden servir con tres enganches.

ACCESORIOS ACCESSORIES

UÑA PARA CIERRE DE CARTOLA CLAW FOR DROPSIDE CATCH

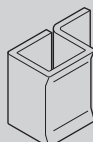

Material	Peso	Acabado	Tipo de cierre	Grosor	Ref.
Acero			Acero	25 / 30	HCUH *
Acero			Aluminio	25	HCUA25
Acero			Aluminio	30	HCUA30

TAPÓN PLÁSTICO PARA CIERRE DE CARTOLA END FOR DROPSIDE CATCH

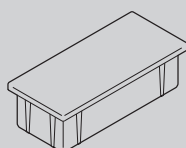
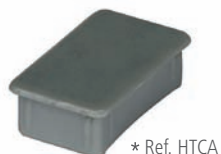

Material	Peso	Acabado	Tipo de cierre	Grosor	Ref.
Plástico			Acero	25	HTCH25
Plástico			Acero	30	HTCH30
Plástico			Aluminio	25 / 30	HTCA *

Nota

CIERRES PARA CARTOLA DROPSIDE CATCHES



PUERTAS TRASERAS
REAR DOORS

CIERRES PARA CARTOLA MODELO "I" DROPSIDE CATCHES MODEL "I"

CIERRE ALUMINIO DELANTERO MODELO "I" FRONT ALUMINIUM CATCH MODEL "I"



* Ref. HCAD4D

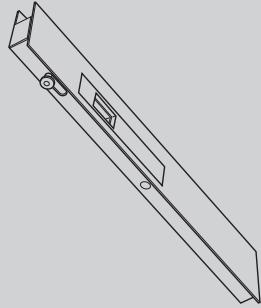

Material	Peso	Acabado	Posición	Largo (A)	Grosor	Ref.
Aluminio	0.62kg	Anodizado	Derecho	400	30	HCAD4D *
Aluminio	0.62kg	Anodizado	Izquierdo	400	30	HCAD4I
Aluminio	0.76kg	Anodizado	Derecho	500	30	HCAD5D
Aluminio	0.76kg	Anodizado	Izquierdo	500	30	HCAD5I

Nota

CANTONERA ALUMINIO PARA CIERRE DELANTERO MODELO "I" ALUMINIUM CORNERPIECE FOR FRONT CATCH MODEL "I"



* Ref. HPAD4D

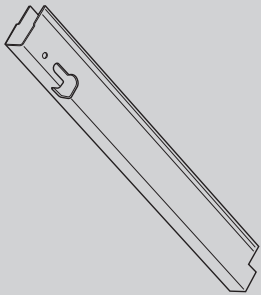

Material	Peso	Acabado	Posición	Largo (A)	Grosor	Ref.
Aluminio	0.34kg	Anodizado	Delantero derecho	400	30	HPAD4D *
Aluminio	0.34kg	Anodizado	Delantero izquierdo	400	30	HPAD4I
Aluminio	0.56kg	Anodizado	Delantero derecho	500	30	HPAD5D
Aluminio	0.56kg	Anodizado	Delantero izquierdo	500	30	HPAD5I

Nota

CIERRE ALUMINIO TRASERO MODELO "I" BACK ALUMINIUM CATCH MODEL "I"



* Ref. HCAT4D

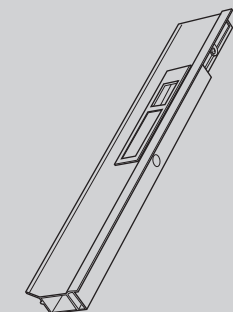

Material	Peso	Acabado	Posición	Largo (A)	Grosor	Ref.
Aluminio	0.72kg	Anodizado	Derecho	400	30	HCAT4D *
Aluminio	0.72kg	Anodizado	Izquierdo	400	30	HCAT4I
Aluminio	0.86kg	Anodizado	Derecho	500	30	HCAT5D
Aluminio	0.86kg	Anodizado	Izquierdo	500	30	HCAT5I

Nota

UÑA DE CIERRE TRASERO MODELO "I" CLAW FOR ALUMINIUM BACK CATCH MODEL "I"

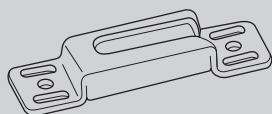

Material	Peso	Acabado	Extra	Ref.
Acero	0.042kg	Cincado		HUCAT

Nota