

TENSORES WINCHES

TENSOR CUERDA MODERNO INCLINADO (PARA SOLDAR) MODERN INCLINED ROPE WINCH (FOR WELDING)

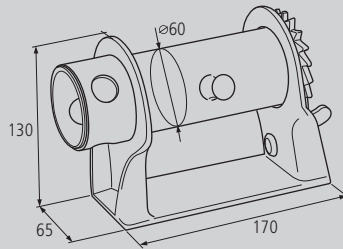

Material	Peso	Acabado	Extra	Ref.
Acero	1.90kg	Pintado		ETI
Nota				

TENSOR CUERDA MODERNO INCLINADO (DESMONTABLE) MODERN INCLINED ROPE WINCH (DETACHABLE)

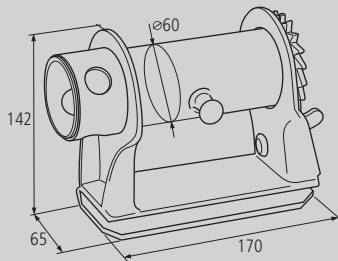

Material	Peso	Acabado	Extra	Ref.
Acero	2.42kg	Pintado		ETA
Nota				

TENSOR ESPECIAL PARA SLINGA (PARA SOLDAR) SPECIAL WINCH FOR SLING (FOR WELDING)

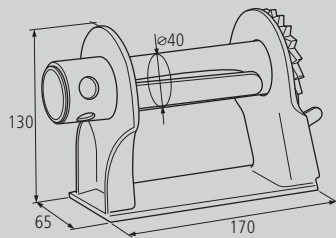

Material	Peso	Acabado	Extra	Ref.
Acero	1.98kg	Pintado		ETES
Nota				

TENSOR ESPECIAL PARA SLINGA (DESMONTABLE) SPECIAL WINCH FOR SLING (DETACHABLE)

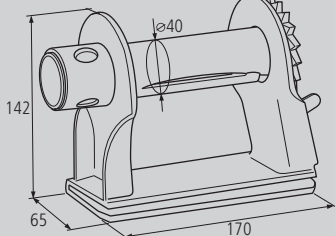

Material	Peso	Acabado	Extra	Ref.
Acero	2.50kg	Pintado		ETEA
Nota				

TENSOR CUERDA GIGANTE PARA GRAN TONELAJE (SIN BASE) GIANT ROPE WINCH FOR LARGE TONNAGE (WITHOUT BASE)

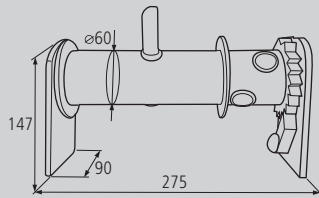

Material	Peso	Acabado	Extra	Ref.
Acero	3.60kg	Pintado		ETG
Nota				

TENSOR CUERDA GIGANTE PARA GRAN TONELAJE (CON BASE) GIANT ROPE WINCH FOR LARGE TONNAGE (WITH BASE)

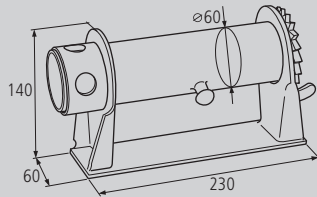

Material	Peso	Acabado	Extra	Ref.
Acero	2.74kg	Pintado		ETGB
Nota				

TENSOR MIXTO DE CUERDA-SLINGA (PARA SOLDAR) SLING-ROPE MIXED WINCH (FOR WELDING)

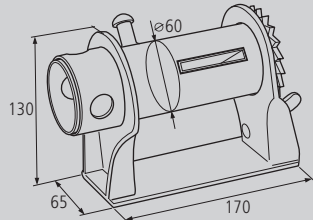

Material	Peso	Acabado	Extra	Ref.
Acero	1.98kg	Pintado		ETMS
Nota				

TENSOR MIXTO DE CUERDA-SLINGA (DESMONTABLE) SLING-ROPE MIXED WINCH (DETACHABLE)

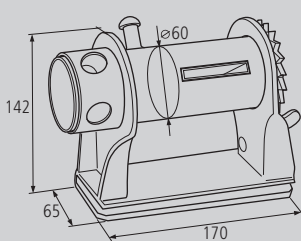

Material	Peso	Acabado	Extra	Ref.
Acero	2.50kg	Pintado		ETMD
Nota				

TENSOR MIXTO DE CUERDA-SLINGA DE 50mm. (PARA SOLDAR) SLING-ROPE MIXED WINCH OF 50mm. (FOR WELDING)

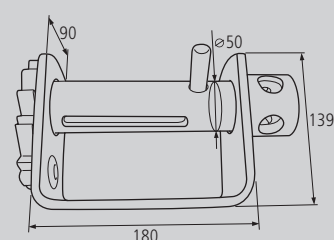

Material	Peso	Acabado	Extra	Ref.
Acero	4.00kg	Pintado		ETMSS
Nota Base: 180/90mm.				



TENSOR MIXTO DE CUERDA-SLINGA DE 60mm. (PARA SOLDAR) SLING-ROPE MIXED WINCH OF 60mm. (FOR WELDING)

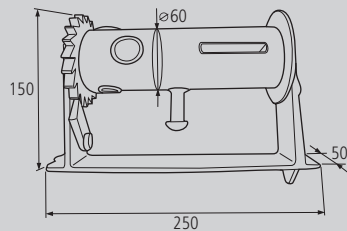

Material	Peso	Acabado	Extra	Ref.
Acero	2.12kg	Pintado		ETMS6

Nota
Base: 250/50mm.

TENSOR MIXTO DE CUERDA-SLINGA DE 60mm. (DESMONTABLE) SLING-ROPE MIXED WINCH OF 60mm. (DETACHABLE)

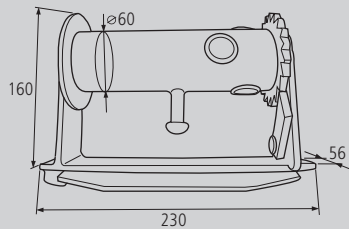

Material	Peso	Acabado	Extra	Ref.
Acero	2.84kg	Pintado		ETMD6

Nota
Base: 235/65mm.

TENSOR MIXTO GRAN TONELAJE (DESMONTABLE) CON PLETINA LARGE TONNAGE MIXED WINCH WITH FLAT BAR (DETACHABLE)

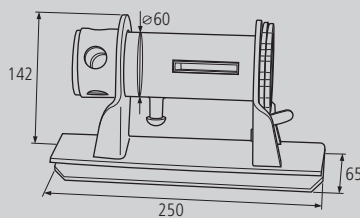

Material	Peso	Acabado	Extra	Ref.
Acero	2.90kg	Cincado		ETMDCM

Nota
Pletina de 250mm.

TENSOR PARA CADENA WINCH FOR CHAIN

TENSOR TIPO CARRACA PARA CADENA RACHET TYPE WINCH FOR CHAIN

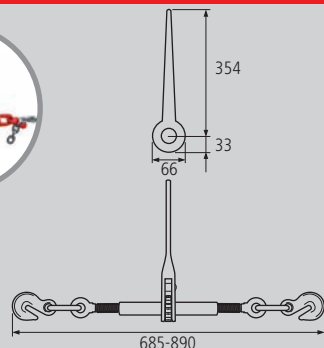

Material	Peso	Acabado	Extra	Ref.
Acero	6.00kg			ETC

Nota