

SLINGAS Y AMARRES SLINGS AND FASTENINGS

AMARRE RÁPIDO DE CARGA FAST LOAD FASTENING

AMARRE RÁPIDO DE CARGA FAST LOAD FASTENING



* Ref. EARC14

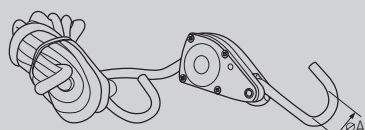

Material	Peso	Acabado	Diámetro interior(A)	Ref.
Varios	0.18kg		1/8"Ø	EARC18
Varios	0.23kg		1/4"Ø	EARC14 *
Varios	0.53kg		3/8"Ø	EARC38
Varios	0.92kg		1/2"Ø	EARC12
Nota				

SLINGAS SUJECCIÓN CARGA LOAD FASTENING SLING

SLINGA SLING

SLINGA (50mm.) GRANDE CON CINTA DE 9m. (Nº1) LARGE SLING (50mm.) WITH 9m. STRIP (No. 1)

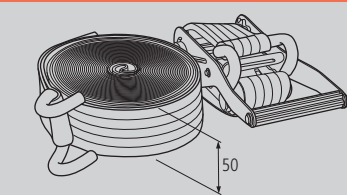

Material	Peso	Acabado	Extra	Ref.
Poliéster / Acero	2.48kg			ETSG
Nota				

COMPONENTES COMPONENTS

TENSOR/CARRACA CON CINTA (50mm.) Y GANCHO (0,5m.)
CINTA (50mm.) CON GANCHO (8,5m.)

Material	Peso	Acabado	Extra	Ref.
Poliéster / Acero	1.28kg			ETESG
Poliéster / Acero	1.20kg			ETSCG

SLINGA (35mm.) MEDIANO CON CINTA DE 3,5m. (Nº2) MEDIUM SLING (35mm.) WITH 3,5m. STRIP (No. 2)

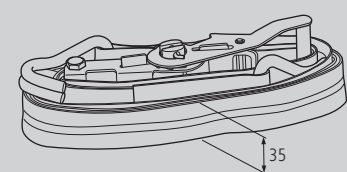

Material	Peso	Acabado	Extra	Ref.
Poliéster / Acero	0.92kg			ETSM
Nota				

COMPONENTES COMPONENTS

TENSOR/CARRACA CON CINTA (35mm.) Y GANCHO (1,2m.)
CINTA (35mm.) CON GANCHO (2,3m.)

Material	Peso	Acabado	Extra	Ref.
Poliéster / Acero	0.66kg			ETESM
Poliéster / Acero	0.26kg			ETSCM

SLINGA (25mm.) PEQUEÑA CON CINTA DE 3,5m. (Nº3) SMALL SLING (25mm.) WITH 3,5m. STRIP (No. 3)

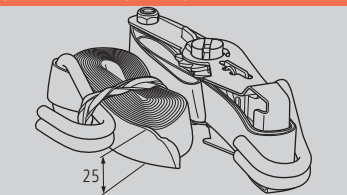

Material	Peso	Acabado	Extra	Ref.
Poliéster / Acero	0.73kg			ETSP
Nota				

COMPONENTES COMPONENTS

TENSOR/CARRACA CON CINTA (25mm.) Y GANCHO (1,2m.)
CINTA (25mm.) CON GANCHO (2,3m.)

Material	Peso	Acabado	Extra	Ref.
Poliéster / Acero	0.52kg			ETESP
Poliéster / Acero	0.21kg			ETSCP

SLINGAS AMARRE INTERIOR INSIDE MOORING SLINGS

SLINGA (50mm.) AMARRE INTERIOR (3,5m.) PERFIL GRANDE (N°4)
SLING (50mm.) INSIDE MOORING (3,5m.) LARGE PROFILE (No. 4)

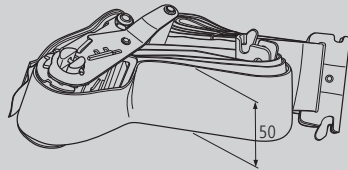

Material	Peso	Acabado	Extra	Ref.
Poliester / Acero	1.01kg			ETIG

Nota

**COMPONENTES
COMPONENTS**

TENSOR/CARRACA CON CINTA (50mm.) Y GANCHO (1,2m.)
CINTA (50mm.) CON GANCHO (2,3m.)

Material	Peso	Acabado	Extra	Ref.
Poliester / Acero	0,71kg			ETIGC
Poliester / Acero	0,30kg			ETICG

SLINGA (50mm.) AMARRE INTERIOR (3,5m.) PERFIL PEQUEÑO (N°5)
SLING (50mm.) INSIDE MOORING (3,5m.) SMALL PROFILE (No. 5)

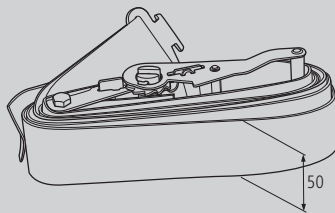

Material	Peso	Acabado	Extra	Ref.
Poliester / Acero	1.01kg			ETIP

Nota

**COMPONENTES
COMPONENTS**

TENSOR/CARRACA CON CINTA (50mm.) Y GANCHO (1,2m.)
CINTA (50mm.) CON GANCHO (2,3m.)

Material	Peso	Acabado	Extra	Ref.
Poliester / Acero	0.71kg			ETIPC
Poliester / Acero	0.30kg			ETICP

ACCESORIOS DE SLINGA SLING ACCESSORIES

**METROS CINTA
STRIP METRES**

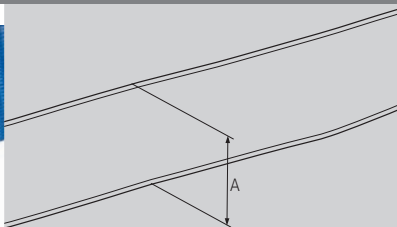

Material	Peso	Acabado	Anchura (A)	Ref.
Poliester 100%			50	EC50
Poliester 100%			35	EC35
Poliester 100%			25	EC25

**GANCHO GRANDE ABIERTO PARA TENSOR SLINGA
LARGE OPEN HOOK FOR SLING TURNBUCKLE**

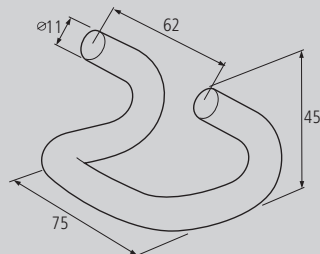

Material	Peso	Acabado	Extra	Ref.
Acero	0.22kg	Bicromatado		EGEGA

SLINGAS Y AMARRES SLINGS AND FASTENINGS

SLINGAS Y AMARRES
SLINGS AND FASTENINGS

GANCHO GRANDE CERRADO PARA TENSOR SLINGA LARGE CLOSED HOOK FOR SLING TURNBUCKLE

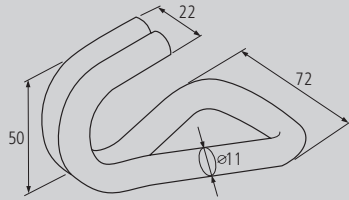

Material	Peso	Acabado	Extra	Ref.
Acero	0.15kg	Bicromatado		EGEGC

GANCHO PEQUEÑO PARA TENSOR SLINGA SMALL HOOK FOR SLING TURNBUCKLE

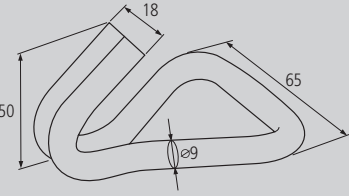

Material	Peso	Acabado	Extra	Ref.
Acero	0.12kg	Bicromatado		EGEP

SOPORTE MUELLE DE SLINGA GRANDE PARA AMARRE INTERIOR SPRING SUPPORT OF LARGE SLING FOR INSIDE MOORING

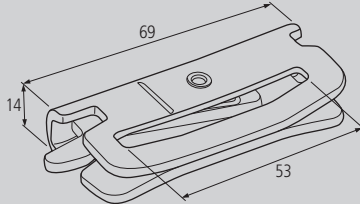

Material	Peso	Acabado	Extra	Ref.
Acero	0.09kg	Bicromatado		EGPEP

SOPORTE MUELLE DE SLINGA PEQUEÑA PARA AMARRE INTERIOR SPRING SUPPORT OF SMALL SLING FOR INSIDE MOORING

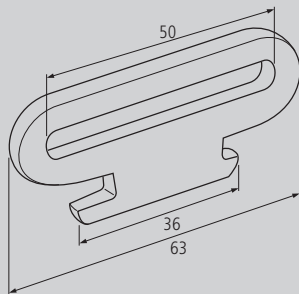

Material	Peso	Acabado	Extra	Ref.
Acero	0.04kg	Bicromatado		EGPEP
Nota				

ENROLLADOR DE SLINGA SLING ROLLER

ENROLLADOR DE SLINGA CON MANIVELA SLING ROLLER WITH HANDLE

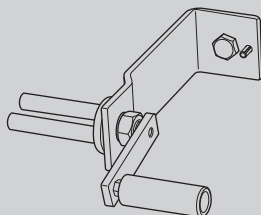

Material	Peso	Acabado	Extra	Ref.
Acero	0.78kg	Cincado		EES
Nota				



PERFIL SUJECIÓN SLINGA PROFILE FOR SLING FASTENING

PERFIL SUJECIÓN SLINGA (ACERO) PROFILE FOR SLING FASTENING (STEEL)

**PERFIL SUJECIÓN SLINGA RANURADO PEQUEÑO (3000x80mm.)
SLOTTED SMALL PROFILE FOR SLING FASTENING (3000x80mm.)**



* Ref. EPS

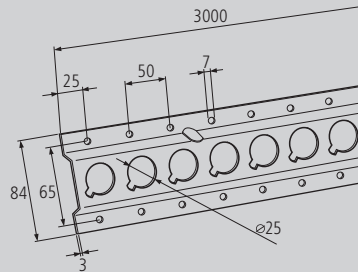

Material	Peso	Acabado	Extra	Ref.
Acero	1.17kg	Cincado		EPS *
Acero INOX	1.18kg			EPSI

Nota
Se vende por metros. Barras de 3000mm.

**TERMINAL PARA PERFIL SUJECIÓN SLINGA PEQUEÑO (80mm.)
TERMINAL OF SMALL PROFILE for SLING FASTENING (80mm.)**

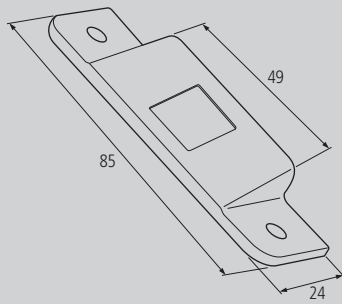

Material	Peso	Acabado	Ref.
Plástico	0.08kg		ETPSP

**PERFIL SUJECIÓN SLINGA RANURADO GRANDE (3000x130mm.)
SLOTTED LARGE PROFILE FOR SLING FASTENING (3000x130mm.)**



* Ref. EPSR

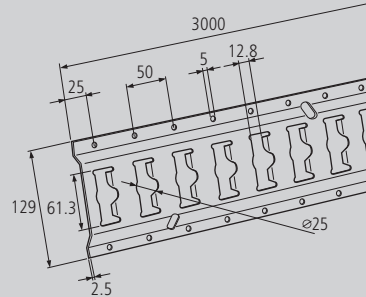

Material	Peso	Acabado	Extra	Ref.
Acero	2.20kg	Cincado		EPSR *
Acero INOX	1.72kg			EPSRI

Nota
Se vende por metros. Barras de 3000mm.

**TERMINAL PARA PERFIL SUJECIÓN SLINGA GRANDE (130mm.)
TERMINAL OF LARGE PROFILE for SLING FASTENING (130mm.)**

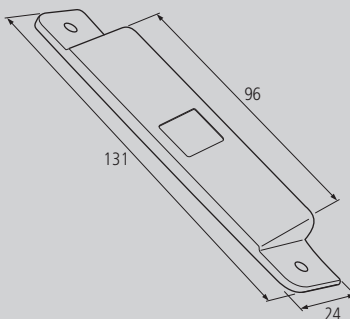

Material	Peso	Acabado	Ref.
Plástico	0.10kg		ETPSG

PERFIL SUJECIÓN SLINGA (ALUMINIO) PROFILE FOR SLING FASTENING (ALUMINIUM)

**PERFIL INT. FURGÓN CON PROTECCIÓN DE CAUCHO (3000x60mm.)
VAN INSIDE PROFILE WITH RUBBER PROTECTION (3000x60mm.)**

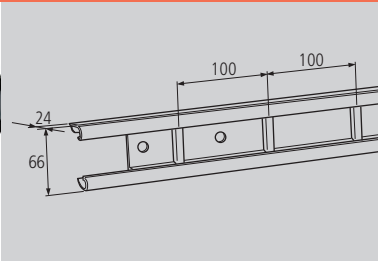

Material	Peso	Acabado	Extra	Ref.
Aluminio / Caucho	3.96kg			EPAP
Nota Se vende en barras de 3000mm.				

**TERMINAL PARA PERFIL INTERIOR FURGÓN (60mm.)
TERMINAL FOR VAN INSIDE PROFILE (60mm.)**

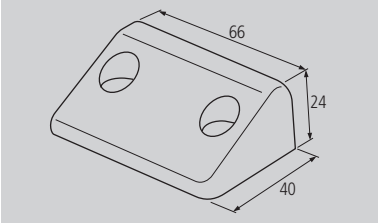

Material	Peso	Acabado	Ref.
Plástico	0.024kg		ETPAP

PERFIL ENMOQUETADO PARA PROTECCIÓN DE CARGA CARPETED PROFILE FOR CARGO PROTECTION

PERFIL ENMOQUETADO PARA PROTECCIÓN DE CARGA (170x30mm.) CARPETED PROFILE FOR CARGO PROT. (170x30mm.)

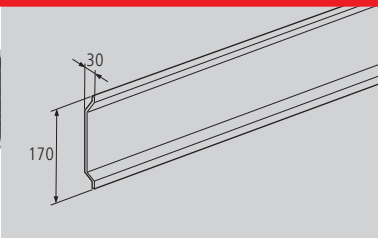

Material	Peso	Acabado	Extra	Ref.
Acero	1.39kg	Galvanizado / Enmoquetado		EPIFM
Nota Se vende en barras de 5000mm.				

PERFIL Y PINZA PARA SUJECIÓN DE CARGA (SISTEMA J.F.S.) PROFILE AND CLAMP FOR CARGO FASTENING (J.F.S. SYSTEM)

RAIL ALUMINIO J.F.S. (3000mm.) ALUMINIUM RAIL (3000mm.)

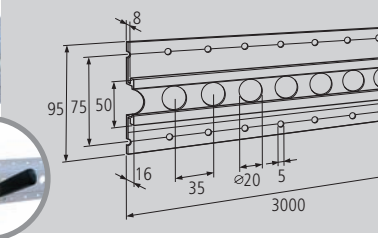
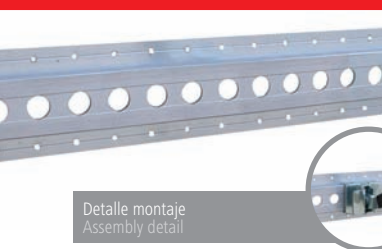

Material	Peso	Acabado	Extra	Ref.
Aluminio	1.50kg			ERJFS
Nota				

PINZA CORREDIZA J.F.S. (B.25) J.F.S. SLIDING CLAMP (B.25)

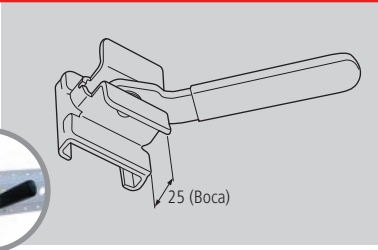
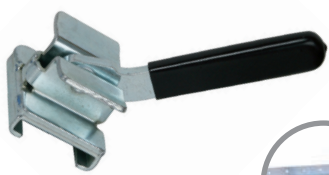

Material	Peso	Acabado	Extra	Ref.
Acero	0.64kg	Cincado		EPCJFS
Nota				