

## PUENTES TIR TIR SEALS

### PUENTE TIR N°2 TIR SEAL No. 2

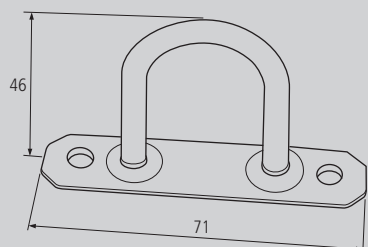

Material	Peso	Acabado	Extra	Ref.
Acero	0.035kg	Cincado		E2
Nota				

### PUENTE TIR N°3 TIR SEAL No. 3

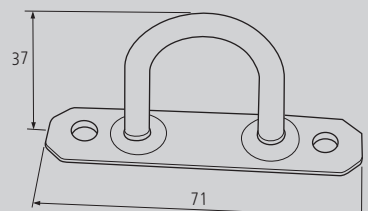

Material	Peso	Acabado	Extra	Ref.
Acero	0.038kg	Cincado		E3
Nota				

### PUENTE TIR N°6 TIR SEAL No. 6



\* Ref. E6

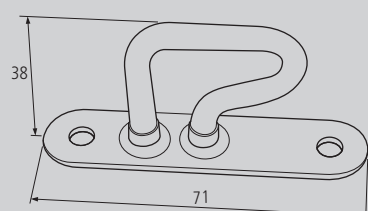

Material	Peso	Acabado	Extra	Ref.
Acero	0.036kg	Cincado		E6 *
Acero INOX	0.034kg			E6I
Nota				

### PUENTE TIR N°10 GIRATORIO ROTATING TIR SEAL No. 10

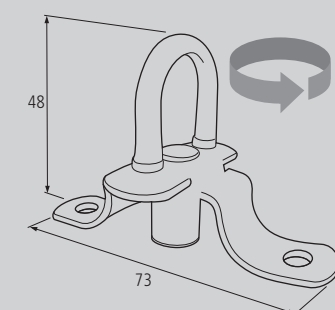

Material	Peso	Acabado	Extra	Ref.
Acero	0.046kg	Cincado		E10
Nota				



**PUENTE TIR Nº10 GIRATORIO ABATIBLE ROTATING FOLDAWAY TIR SEAL No. 10**

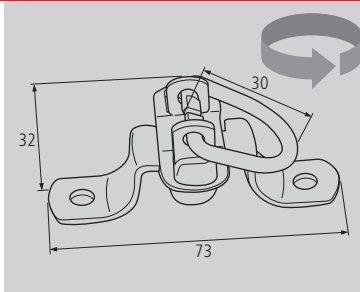

Material	Peso	Acabado	Extra	Ref.
Acero	0.044kg	Cincado		E10A
Nota				

**PUENTE TIR Nº10 GIRATORIO CON PATILLA SOLDADA (PARA FRONTAL)  
ROTATING FOLDAWAY TIR SEAL No. 10 WITH WELDED PIN (FOR FRONT)**

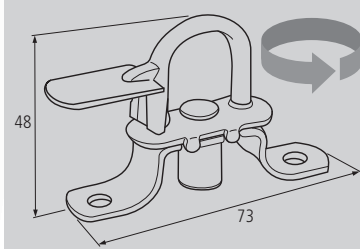

Material	Peso	Acabado	Extra	Ref.
Acero	0.054kg	Cincado		E10F
Nota				

**PUENTE TIR Nº11 TIR SEAL No. 11**



\* Ref. E11

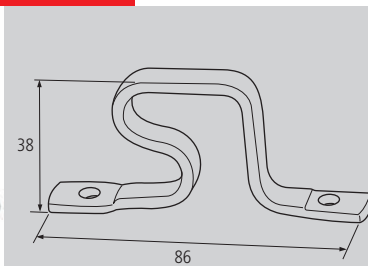

Material	Peso	Acabado	Extra	Ref.
Acero	0.044kg	Cincado		E11 *
Aluminio	0.014kg			E11A *
Nota				

**PUENTE TIR Nº12 TIR SEAL No. 12**



\* Ref. E12

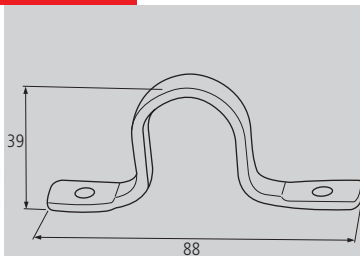

Material	Peso	Acabado	Extra	Ref.
Acero	0.036kg	Cincado		E12 *
Aluminio	0.012kg			E12A *
Nota				

**PUENTE TIR Nº13 TIR SEAL No. 13**



\* Ref. E1325

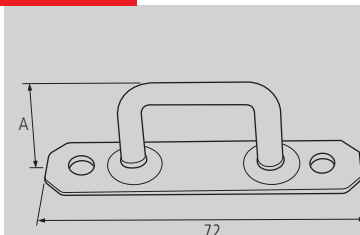

Material	Peso	Acabado	Alto (A)	Ref.
Acero	0.028kg	Cincado	15	E1315
Acero	0.028kg	Cincado	25	E1325 *
Acero	0.032kg	Cincado	35	E1335
Nota				