

# DEPOSITOS AGUA WATER TANKS

## DEPOSITOS AGUA PLÁSTICO PLASTIC WATER TANKS

### DEPOSITOS AGUA MODELO "A" WATER TANKS MODEL "A"

#### DEPOSITO AGUA 30 LITROS 30 LITRE WATER TANK



\*Ref. AB3

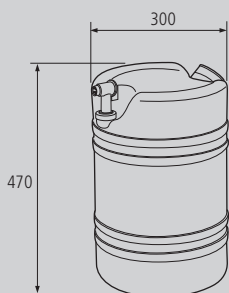

Material	Peso	Acabado	Capacidad	Ref.
Plástico	2.00kg	Blanco	30 litros	AB3 *
Plástico	2.00kg	Negro	30 litros	AB3N
Nota				

#### DEPOSITO AGUA 50 LITROS 50 LITRE WATER TANK

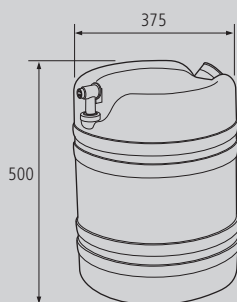

Material	Peso	Acabado	Capacidad	Ref.
Plástico	2.68kg	Blanco	50 litros	AB5
Nota				

#### DEPOSITO AGUA 30 LITROS CON TAPÓN/DOSIFICADOR 30 LITRE TANK WITH STOPPER/DISPENSER



\*Ref. AB3J

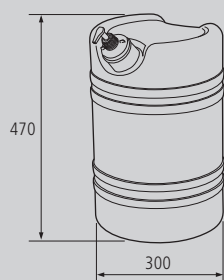

Material	Peso	Acabado	Capacidad	Ref.
Plástico	2.06kg	Blanco	30 litros	AB3J *
Plástico	2.06kg	Negro	30 litros	AB3JN
Nota				

#### DEPOSITO AGUA 50 LITROS CON TAPÓN/DOSIFICADOR 50 LITRE TANK WITH STOPPER/DISPENSER

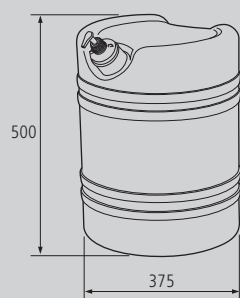

Material	Peso	Acabado	Capacidad	Ref.
Plástico	2.74kg	Blanco	50 litros	AB5J
Nota				



ACCESORIOS MODELO "A" ACCESSORIES MODEL "A"

GRIFO PARA DEPÓSITO DE AGUA  
TAP FOR TANK WATER

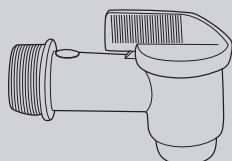

Material	Peso	Acabado	Extra	Ref.
Plástico	0.02kg			AG

TAPÓN PARA DEPÓSITO DE AGUA  
STOPPER FOR TANK WATER

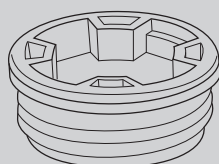

Material	Peso	Acabado	Extra	Ref.
Plástico	0.02kg			AT

BRIDA PARA DEPÓSITO DE 30 Y 50 LITROS  
CLAMP FOR 30 AND 50 LITRE WATER TANK



\*Ref. ABD3

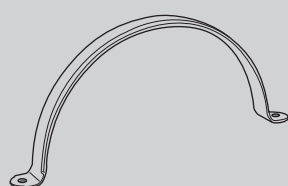

Material	Peso	Acabado	Tipo	Ref.
Acero	0.28kg	Galvanizado	30 litros	ABD3 *
Acero	0.34kg	Galvanizado	50 litros	ABD5

DOSIFICADOR PARA DEPÓSITO DE AGUA  
DISPENSER FOR WATER TANK

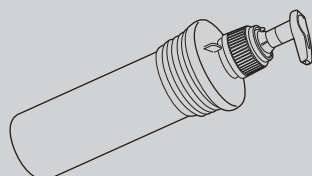

Material	Peso	Acabado	Extra	Ref.
Plástico	0.06kg			ABDA

Nota

DEPOSITOS AGUA MODELO "L" WATER TANKS MODEL "L"

DEPOSITO AGUA 30 LITROS CON DOSIFICADOR  
30 LITRE WATER TANK WITH DISPENSER



\*Ref. AB3L

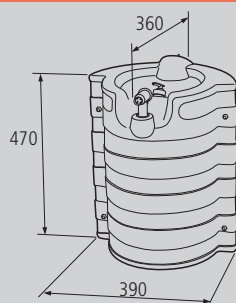

Material	Peso	Acabado	Capacidad	Ref.
Plástico	3.36kg	Blanco	30 litros	AB3LB
Plástico	3.36kg	Negro	30 litros	AB3L *

Nota

# DEPOSITOS AGUA WATER TANKS



## DEPOSITO AGUA CUADRADO 30 LITROS CON DOSIFICADOR 30 LITRE OBLONG WATER TANK WITH DISPENSER

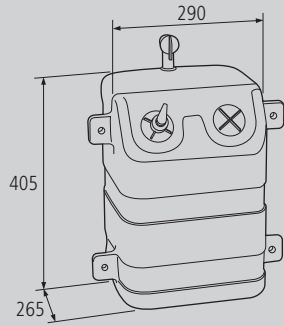

Material	Peso	Acabado	Capacidad	Ref.
Plástico	2.02kg	Negro	30 litros	AB3LC
Nota				

## ACCESORIOS MODELO "L" ACCESSORIES MODEL "L"

### TAPÓN PARA DEPÓSITO DE AGUA STOPPER FOR WATER TANK

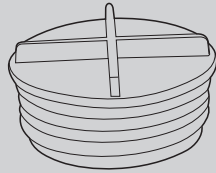

Material	Peso	Acabado	Extra	Ref.
Plástico	0.02kg			ATL

### DOSIFICADOR PARA DEPÓSITO DE AGUA DISPENSER FOR WATER TANK

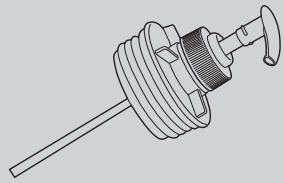

Material	Peso	Acabado	Extra	Ref.
Plástico	0.02kg			ADL

### JUEGO DE SOPORTES PARA DEPÓSITO DE AGUA (600mm.) SET OF BRACKETS FOR DEPÓSITO DE AGUA (600mm.)

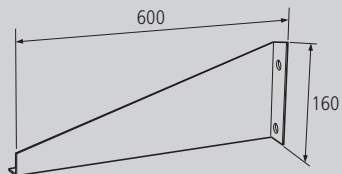

Material	Peso	Acabado	Extra	Ref.
Acero	3.40kg	Galvanizado		AB3LS
Nota				

DEPOSITOS AGUA MODELO "D" WATER TANKS MODEL "D"

DEPOSITO AGUA 30 LITROS CON DOSIFICADOR  
30 LITRE WATER TANK WITH DISPENSER

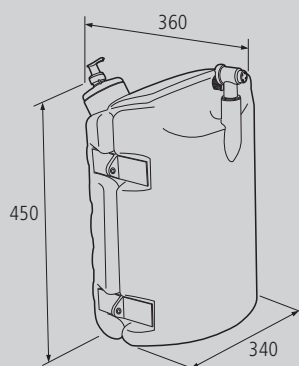

Material	Peso	Capacidad	Extra	Ref.
Plástico	3.04kg	Negro	30 litros	AB3D

Nota	Laterales inferiores
------	----------------------

ACCESORIOS MODELO "D" ACCESSORIES MODEL "D"

GRIFO PARA DEPÓSITO DE AGUA  
TAP FOR TANK WATER

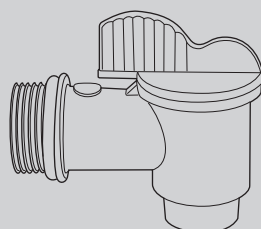

Material	Peso	Acabado	Extra	Ref.
Plástico	0.02kg			AGD

TAPÓN/DOSIFICADOR PARA DEPÓSITO DE AGUA  
STOPPER/DISPENSER FOR TANK WATER

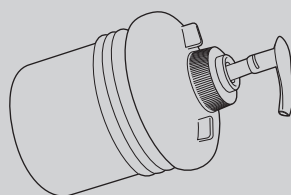

Material	Peso	Acabado	Extra	Ref.
Plástico	0.06kg			ATD

JUEGO DE SOPORTES PARA DEPÓSITO DE AGUA (410mm.)  
SET OF BRACKETS FOR TANK WATER (410mm.)

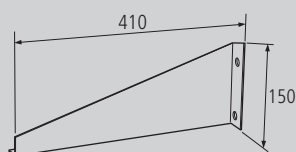

Material	Peso	Acabado	Extra	Ref.
Acero	2.52kg	Galvanizado		AB3DS

Nota	Laterales inferiores
------	----------------------

**DEPOSITOS AGUA CHAPA INOXIDABLE STAINLESS STEEL WATER TANKS**

**DEPOSITO AGUA CUADRADO CHAPA INOXIDABLE 25 LITROS 25 LITRES OBLONG STAINLESS STEEL WATER TANK**

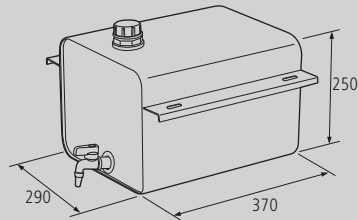

Material	Peso	Acabado	Capacidad	Ref.
Acero INOX	4.18kg		25 litros	ABI
Nota				

**DEPOSITO AGUA ESTRECHO CHAPA INOXIDABLE 25 L. 25 LITRES NARROW STAINLESS STEEL WATER TANK**

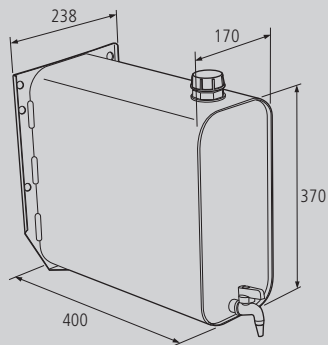

Material	Peso	Acabado	Capacidad	Ref.
Acero INOX	6.50kg		25 litros	ABIE
Nota				

**ACCESORIOS ACCESSORIES**

**TAPÓN PARA DEPÓSITO DE AGUA  
STOPPER FOR WATER TANK**

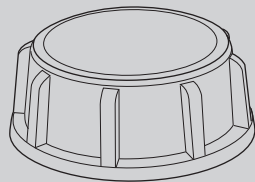

Material	Peso	Acabado	Extra	Ref.
Plástico	0.02kg			ATI

**GRIFO PARA DEPÓSITO DE AGUA  
TAP FOR TANK WATER**

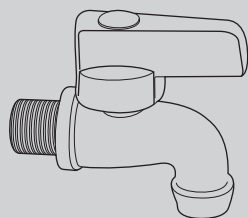

Material	Peso	Acabado	Extra	Ref.
Metal	0.12kg			AGI
Nota				