

# ALETAS MUDGUARDS



## ALETAS MIXTAS (CHAPA GALVANIZADA Y CANTO DE GOMA) MIXED MUDGUARDS (GALVANIZED PLATE WITH RUBBER EDGE)

### ALETA MIXTA (CHAPA GALV. Y CANTO DE GOMA) SENCILLA MIXED MUDGUARD (GALV. STEEL WITH RUBBER EDGE) SINGLE



\* Ref. A7C

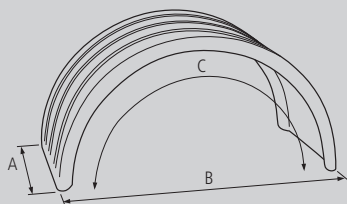

Material	Peso	Acabado	A	B	C	Ref.
Acero	10.40kg	Galvanizado	650	1340	2100	A7A
Acero	8.90kg	Galvanizado	650	1170	1800	A7J
Acero	8.30kg	Galvanizado	600	1170	1800	A7B
Acero	9.30kg	Galvanizado	600	1260	2000	A7BL
Acero	7.30kg	Galvanizado	550	1100	1700	A7C
Acero	6.80kg	Galvanizado	500	1100	1700	A7D
Acero	7.20kg	Galvanizado	500	1170	1800	A7DL
Acero	5.40kg	Galvanizado	450	880	1450	A7E
Acero	5.70kg	Galvanizado	450	980	1570	A7EL
Acero	7.90kg	Galvanizado	450	1340	2100	A7H
Acero	4.40kg	Galvanizado	400	820	1300	A7F
Acero	4.80kg	Galvanizado	400	880	1450	A7FL
Acero	3.30kg	Galvanizado	280	800	1250	A7G

Nota  
Canto de goma.

### ALETA MIXTA (CHAPA GALVANIZADA Y CANTO DE GOMA) TANDEM/TRIDENT MIXED MUDGUARD (GALVANIZED PLATE WITH RUBBER EDGE) TANDEM/TRIDENT



\* Ref. A6A

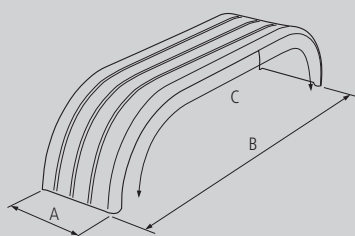

Material	Peso	Acabado	A	B	C	Ref.
Acero	17.60kg	Galvanizado	650	2740	3550	A6A
Acero	18.40kg	Galvanizado	450	4100	5000	A6D
Acero	24.80kg	Galvanizado	650	4100	5000	A6C

Nota  
Canto de goma.

## ALETAS MIXTAS (CHAPA INOXIDABLE Y CANTO DE GOMA) MIXED MUDGUARDS (STAINLESS STEEL WITH RUBBER EDGE)

### ALETA MIXTA (CHAPA INOXIDABLE Y CANTO DE GOMA) SENCILLA MIXED WING (S.S. WITH RUBBER EDGE) SINGLE

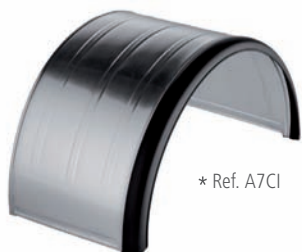

\* Ref. A7CI

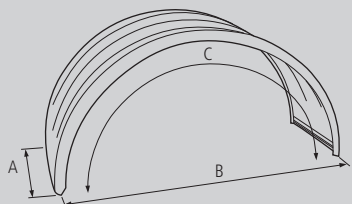

Material	Peso	Acabado	A	B	C	Ref.
Acero INOX	10.40kg		650	1340	2100	A7AI
Acero INOX	8.30kg		600	1170	1800	A7BI
Acero INOX	7.30kg		550	1100	1700	A7CI
Acero INOX	6.30kg		500	980	1570	A7DI
Acero INOX	5.70kg		450	980	1570	A7EI
Acero INOX	7.90kg		450	1340	2100	A7HI

Nota  
Canto de goma.

**ALETA MIXTA (CHAPA INOXIDABLE Y CANTO DE GOMA) TANDEM/TRIDENT**  
**MIXED WING (STAINLESS STEEL WITH RUBBER EDGE) TANDEM/TRIDENT**



\* Ref. A6AI

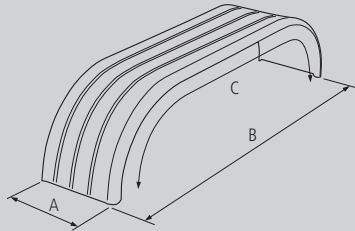

Material	Peso	Acabado	A	B	C	Ref.
Acero INOX	17.60kg	Brillo espejo	650	2740	3550	A6AI *
Acero INOX	18.40kg	Brillo espejo	450	4100	5000	A6DI *
Acero INOX	24.80kg	Brillo espejo	650	4100	5000	A6CI *

**Nota**  
Canto de goma.

**ALETAS TERMOPLÁSTICAS THERMOPLASTIC MUDGUARDS**

**ALETA TERMOPLÁSTICA SENCILLA SINGLE THERMOPLASTIC MUDGUARD**



\* Ref. APD55

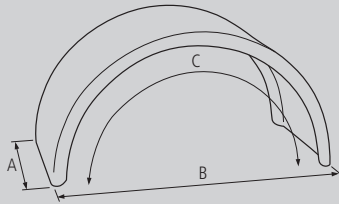

Material	Peso	Acabado	A	B	C	Ref.
Plástico	1.23kg		270	840	1300	APD25
Plástico	2.11kg		410	860	1350	APD40
Plástico	3.33kg		430	1300	2125	APD45L
Plástico	2.29kg		450	860	1350	APD45
Plástico	2.60kg		500	1000	1620	APD50
Plástico	3.14kg		550	1120	1780	APD55 *
Plástico	3.14kg		600	1160	1840	APD60
Plástico	3.37kg		600	1280	1900	APD60L
Plástico	4.32kg		670	1340	2125	APD65

**Nota**

**ALETA TERMOPLÁSTICA PARLOCK PARLOCK THERMOPLASTIC MUDGUARD**



\* Ref. ATP55

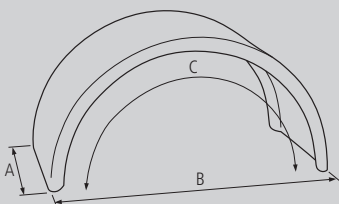

Material	Peso	Acabado	A	B	C	Ref.
Plástico	3.27kg		430	1300	2175	ATP43P
Plástico	3.27kg		550	1100	1700	ATP55 *
Plástico	3.73kg		600	1160	1850	ATP60
Plástico	4.82kg		650	1260	1900	ATP65

**Nota**

**ALETA TERMOPLÁSTICA TANDEM (DOBLE EJE) TANDEM THERMOPLASTIC MUDGUARD (DOUBLE AXLE)**

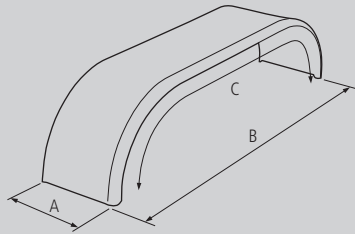

Material	Peso	Acabado	A	B	C	Ref.
Plástico	10.80kg		650	2680	3345	A16F

Nota

**MEDIA ALETA TERMOPLÁSTICA HALF THERMOPLASTIC MUDGUARD**

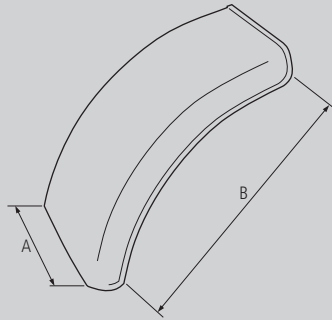

Material	Peso	Acabado	A	B	Ref.
Plástico	1.60kg		430	800	AMT4
Plástico	1.80kg		650	800	AMT6

Nota

**ALETA TERMOPLÁSTICA BASE PLANA LEVEL BASE THERMOPLASTIC MUDGUARD**



\* Ref. APD45P

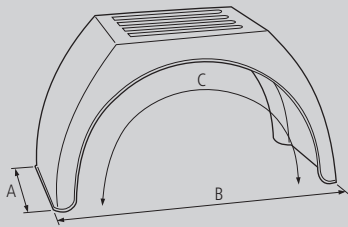

Material	Peso	Acabado	A	B	C	Ref.
Plástico	2.65kg		420	860	1380	AP42BP
Plástico	2.85kg		450	920	1480	APD45P*
Plástico	3.50kg		510	1000	1770	APD50P

Nota

